

KOBELCO

SK350LC/SK350NLC-11E

Performance  Design

SK350_{LC} SK350_{NLC}

- Bucket capacity:
1.20 – 1.80 m³
- Engine power:
210 kW / 1,900 min⁻¹
- Operating weight:
36,900 – 39,700 kg



Complies with the EU Stage V
exhaust emission regulation

Built for Perfectionists™



Performance Design

SK350LC/SK350NLC of KOBELCO has realised a completely new value by harmonising PERFORMANCE and DESIGN.

Performance enhancements offer greater efficiency and productivity along with increased power and speed.

Design improvements provide the ultimate in comfort and control. KOBELCO refuses to compromise, creating machines that meet every challenge.



KOBELCO

KOBELCO

SK350 LC

THE ULTIMATE IN SIMPLE DESIGN

In our pursuit of functional beauty and styling,
we created an all new interior design focused with the operator in mind.

Jog Dial

This dial integrates multiple functions into a single, easy to use interface. Even with gloves on, the operator can make the adjustments they need.

LED Illumination

Dials and buttons are now backlit to provide a bright, clear view in any lighting condition.







UNFORGETTABLE COMFORT

Air suspension seat

A GRAMMER* seat is installed as standard equipment, which achieves excellent shock absorption and superior ride comfort.

*GRAMMER is trademark of GRAMMER AG, registered in Germany and other countries.

Multi Vent Air Conditioner

Cool air is blown from multiple outlets toward the operator's body for more comfortable operation.

Ergonomic Lever Angles

Operators can move levers horizontally without twisting their wrists, reducing fatigue.



New Hydraulic Control

Our newly upgraded hydraulic control system responds to shorter lever strokes than previous models, delivering swifter, more precise movement and improved lever operability.

LED Interior Light

Interior lights turn on and off automatically when the door is open or the ignition is turned to the OFF position. This ensures safe entry and exit in the dark.

Parallel wipers secure a wide field of view



KOBELCO



04:33



SETTING MENU



PICTURE OF CAMERA



CLOCK SETTING



SCREEN BRIGHTNESS



MAINTENANCE



CONSUMPTION



LANGUAGE SELECTION



PRESSURE RELEASE



SAFETY ON FULL DISPLAY

Standard 3 Sides Safety Camera System

Our high-resolution, large display shows right, left and rear side cameras together. Multiple display allows the operator to customize viewing needs to enhance operator awareness and jobsite safety.

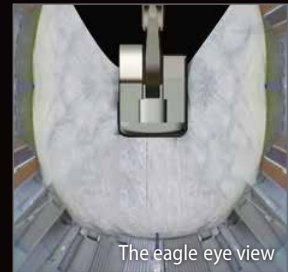
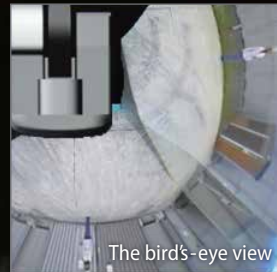
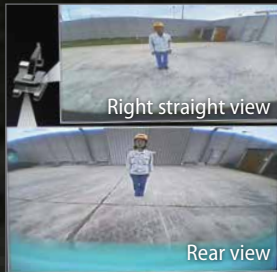

Large 10-Inch Color Monitor

The easy-to-operate menu screen and recognizable icons assist the operator to select the most important information needed to ensure jobsite safety and machine control.



Dial in the Right Information

Simply turn the jog dial to the right or left to select an operational feature, then press the dial to confirm selection.

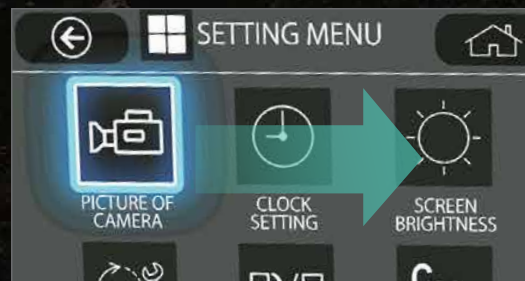



Independent Travel

Selecting Independent Travel dedicates one hydraulic pump to travel and one to the attachment on a continuous basis, allowing for a smooth and constant movement speed even while swinging or using the boom or attachment. With Independent Travel, safely carrying a large pipe across a job site is a breeze.

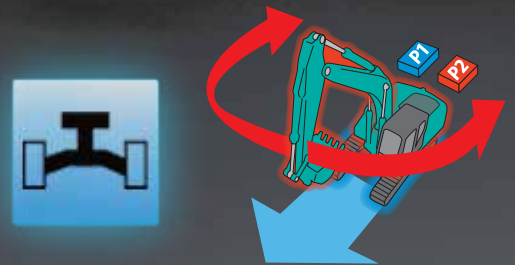

EXPERIENCING A COMPETENT PERFORMANCE

Excellent machine stability, plus an EU Stage V compliant engine

The new SK350LC/NLC is equipped with a Stage V compliant engine, which has a higher torque value. Superior balance between engine output and torque contributes to more efficient performance than the previous models. In addition, the DPF maintenance interval has been extended.

Model: ISUZU 6HK1

Engine output

210_{kW} / 1,900_{min⁻¹}



Max. bucket digging force (Arm 3.30 m)

Normal: **222** kN

With Power Boost: **244** kN

Lift capacity

18,060 kg

(Reach: 4.50 m Boom: 6.50 m Arm: 3.30 m Bucket: without
Shoe: 600 mm <Heavy Lift> At Ground Level)



GREATER MULTI-FUNCTION CAPABILITIES

Attachment mode selection

The auxiliary flow rates for the bucket, breaker, nibbler, and rotating are all now adjustable by the operator through the monitor, allowing you to change tools quickly and easily. Mode settings for other attachments like the tilt rotator can be added or changed.



EASY MAINTENANCE



Standard Overhead Top Guard Level II

The standard overhead cab guard can be tilted open with gas damper* for easy window cleaning. Meets standard top guard level II requirements (ISO 10262).



Engine Maintenance

Lower service platform makes engine service easier.



Two-stage air filter



DEF/AdBlue® Tank

The DEF/AdBlue® fill is located inside the locking tool box.



Left side (radiator and cooling system elements)

Laid out for easy access to radiator and cooling system.

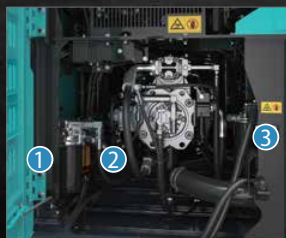

Right Side (Ground Level Maintenance)



1 Fuel Filter 2 Pre-Filter with Integrated Water Separator



3 Engine oil filter

Note: AdBlue® is a registered trademark of the Verband der Automobilindustrie e.V. (VDA).
*Gas damper is not applicable for 2 piece boom specification.

DURABILITY YOU CAN TRUST

Enhanced body rigidity for 35-ton class machines

The SK350LC/SK350NLC machines are widely used in mid-scale construction projects and harsh worksites. The components have been reviewed and improvements have been made to their durability to ensure stable performance in such environments.



Panels and supports

The right and left side panels and rear supports have been thicker to enhance body rigidity.

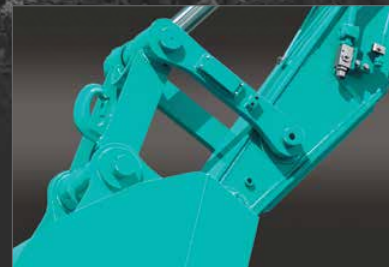

Bucket cylinder rod pin

The increased diameter of the bucket cylinder rod pin contributes to enhanced durability for various types of attachments.

CONVENIENT AND SENSIBLE EQUIPMENT



Engine start password

A password is required when starting the engine for greater security.



Wiper adjustment function

In addition to the intermittent wiper mode and continuous wiper mode, the one-time wiper mode was added.



Parallel wiper

Sun screen



Console mount

The console-integrated seat allows for comfortable operation.



DAB+ radio (FM/AM & AUX & USB & Bluetooth® & hands-free telephone)



USB port/12V power outlet



Smartphone holder

You can use the holder with your smartphone connected to the USB port.



KOBELCO MONITORING EXCAVATOR SYSTEM



Remote Monitoring for Peace of Mind

KOMEXS (Kobelco Monitoring Excavator System) uses satellite communication and internet to relay data, and therefore can be deployed in areas where other forms of communication are difficult. When a hydraulic excavator is fitted with this system, data on the machine's operation, such as operating hours, location, fuel consumption, and maintenance status can be obtained remotely.

Direct Access to Operational Status

Location Data

Accurate location data can be obtained even from sites where communications are difficult.

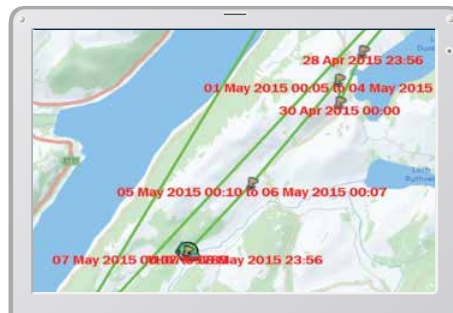
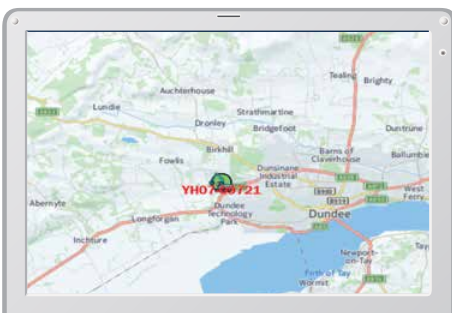

Work data

Period	11 Apr, 2015	to	10 May, 2015	Search
Type of Operation	Working Hrs		Ratio	
Total Working Hrs	169 Hrs		100 %	
Digging Hrs	72.2 Hrs		43 %	
Traveling Hrs	18.3 Hrs		11 %	
Idle Hrs	15.9 Hrs		9 %	
Opt Att Hrs	62.5 Hrs		37 %	
Crane Mode Hrs	0 Hrs		0 %	

Operating Hours

- A comparison of operating times of machines at multiple locations shows which locations are busier and more profitable.
- Operating hours on site can be accurately recorded, for running time calculations needed for rental machines, etc.

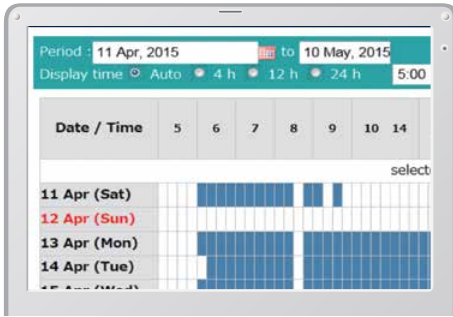

Daily report

Fuel Consumption Data

Data on fuel consumption and idling times can be used to indicate improvements in fuel consumption.

Work mode	Working Hrs	Total Fuel Consumption
H mode	2:06	24.5 L
S mode	0:00	0.0 L
E mode	169:19	1489.7 L
TOTAL	171:25	1514.2 L

Fuel consumption

Graph of Work Content

The graph shows how working hours are divided among different operating categories, including digging, idling, travelling and optional operations.

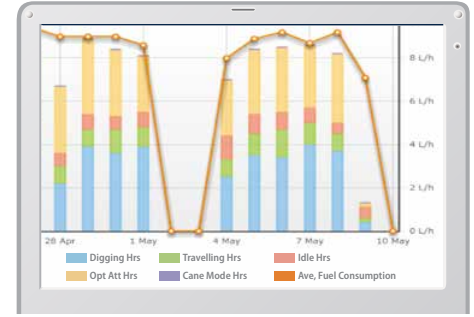

Work status

Maintenance Data and Warning Alerts

Machine Maintenance Data

- Provides maintenance status of separate machines operating at multiple sites.
- Maintenance data is also relayed to KOBELCO service personnel, for more efficient planning of periodic servicing.

Model	Serial No.	Hour Meter	Engine Oil
SK135SRLC-3/SK140SRL	YH07-09721	734 Hr	434
SK135SRLC-3/SK140SRL	YH07-09789	73 Hr	429
SK210LC-9	YQ13-10454	960 Hr	58
SK210LC-9	YQ13-10481	549 Hr	498
SK75SR-	YT08-30374		

Maintenance

Warning Alerts

This system warns an alert if an anomaly is sensed, preventing damage that could result in machine downtime.

Alarm Information Can Be Received through E-mail

Alarm information or maintenance notice can be received through E-mail, using a computer or cell phone.



Alarm messages can be received on mobile device.

Daily/Monthly Reports

Operational data downloaded onto a computer helps in formulating daily and monthly reports.

Security System

Engine Start Alarm

The system can be set an alarm if the machine is operated outside designated time.

Engine start alarm outside prescribed work time

Area Alarm

It can be set an alarm if the machine is moved out of its designated area to another location.

Alarm for outside of reset area

Specifications



Engine

Model	ISUZU 6HK1
Type	Four-cycle, water-cooled, direct injection diesel engine, turbo charged, EU Stage V exhaust emission regulation
No. of cylinders	6
Bore and stroke	115 mm x 125 mm
Displacement	7,790 L
Rated power output	198 kW/1,900 min ⁻¹ (ISO 9249 : with fan)
	210 kW/1,900 min ⁻¹ (ISO 14396: without fan)
Max. torque	1,011 N-m/1,500 min ⁻¹ (ISO 9249 : with fan)
	1,080 N-m/1,500 min ⁻¹ (ISO 14396: without fan)



Hydraulic System

Pump	
Type	Two variable displacement axial piston pumps + extra gear pump + pilot gear pump
Max. discharge flow	2 x 294 L/min, 1 x 44.3 L/min, 1 x 19 L/min
Relief valve setting	
Boom, arm and bucket	34.3 MPa
Power Boost	37.8 MPa
Travel circuit	35.8 MPa
Swing circuit	29.5 MPa
Control circuit	5.0 MPa
Pilot control pump	Gear type
Main control valve	8-spool valve
Oil cooler	Air cooled type



Swing System

Swing motor	One fixed displacement piston motor
Brake	Hydraulic; locking automatically when the swing control lever is in the neutral position
Parking brake	Wet multiple plate
Swing speed	10.0 min ⁻¹
Swing torque	120 kN-m
Maximum swing gradient (Loaded)*	30 % {17°}

*Value for the least favourable specification



Attachments

Backhoe bucket and combination

Use	Backhoe bucket					
			Normal digging		Light-duty	
Bucket capacity	ISO heaped	m ³	1.20	1.40	1.60	1.80
Opening width	With side cutter	mm	1,240	1,420	1,570	-
	Without side cutter	mm	1,110	1,300	1,450	1,680
No. of teeth			4	5	5	5
Bucket weight		kg	930	1,070	1,140	1,200
Combination	2.60 m short arm		○	○	◎	△
	3.30 m standard arm		○	◎	△	×
	4.15 m long arm		◎	△	×	×

◎ Standard ○ Recommended △ Loading only × Not recommended



Travel System

Travel motors	2 × axial-piston, two-step motors
Travel brakes	Hydraulic brake per motor
Parking brakes	Oil disc brake per motor
Travel shoes	48 each side
Travel speed	5.6/3.3 km/h
Rated drawbar pull	321 kN (SAE J 1309)
Gradeability	70 % {35°}



Cab & Control

Cab

All-weather, sound-suppressed steel cab mounted on the high suspension mounts filled with silicone oil and equipped with a heavy, insulated floor mat.

Control

Two hand levers and two foot pedals for travel

Two hand levers for excavating and swing

Electric rotary-type engine throttle

Noise levels

External 106 dB(A) (2000/14/EC)

Operator 73 dB(A) (ISO 6396)

Vibration levels

Hand/arm* ≤ 2.5 m/s²

Body* ≤ 0.5 m/s²

*For the risk assessment according to 2002/44/EC, refer to ISO/TR 25398: 2006



Cylinders

Boom cylinders	140 mm x 1,550 mm
Arm cylinder	170 mm x 1,788 mm
Bucket cylinder	150 mm x 1,193 mm
Jib cylinder*	170 mm x 1,335 mm

*For 2 Piece boom only



Refilling Capacities & Lubrications

Fuel tank	503 L
Cooling system	41.4 L
Engine oil	48.6 L
Travel reduction gear	2 x 8.0 L
Swing reduction gear	1 x 7.4 L
Hydraulic oil tank	245 L tank oil level
	410 L hydraulic system
DEF/Urea tank	83 L



Working Ranges

Unit: mm

Range	Arm	6.50 m		
		Short 2.60 m	Standard 3.30 m	Long 4.15 m
a- Max. digging reach		10,610	11,260	11,970
b- Max. digging reach at ground level		10,400	11,060	11,790
c- Max. digging depth		6,860	7,560	8,410
d- Max. digging height		10,260	10,580	10,700
e- Max. dumping clearance		7,060	7,370	7,530
f- Min. dumping clearance		3,320	2,620	1,760
g- Max. vertical wall digging depth		5,840	6,610	7,270
h- Min. swing radius		4,460	4,310	4,430
i- Horizontal digging stroke at ground level		4,210	5,820	7,210
j- Digging depth for 2.4 m (8') flat bottom		6,670	7,400	8,270
Bucket capacity ISO heaped m ³		1.60	1.40	1.20

Digging Force (ISO 6015)

Unit: kN

Arm length	Short 2.60 m	Standard 3.30 m	Long 4.15 m
Bucket digging force	221 243*	222 244*	220 242*
Arm crowding force	205 225*	163 180*	140 154*

*Power Boost engaged.

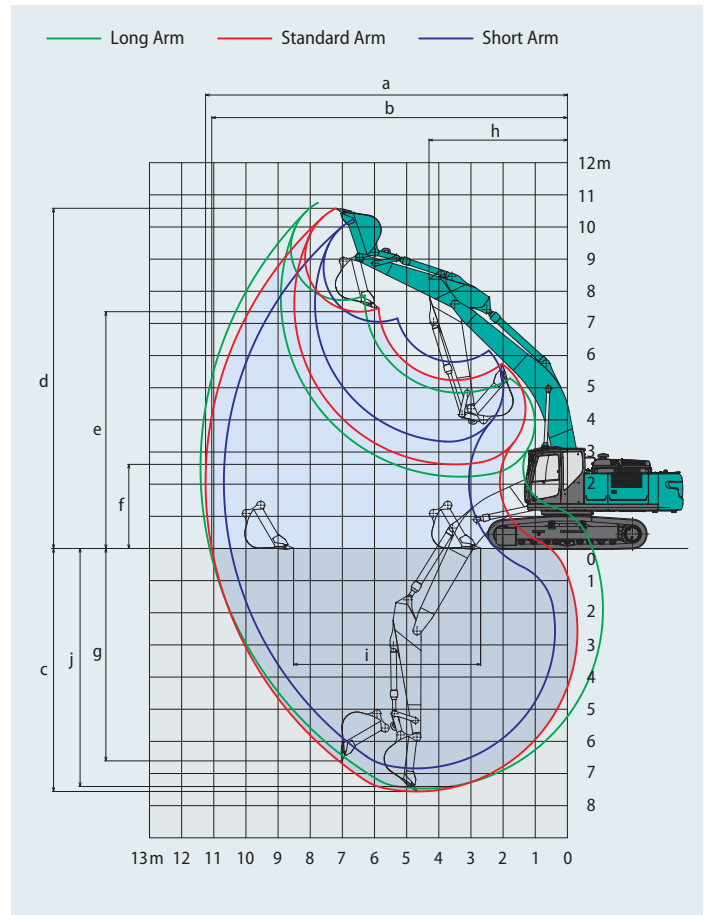

Dimensions

Arm length	Short 2.60 m	Standard 3.30 m	Long 4.15 m
A Overall length	11,380	11,300	11,330
B Overall height (to top of boom)	3,690	3,420	3,590
C Overall width of crawler	SK350LC	3,190	
	SK350NLC	2,990	
D Overall height (to top of cab)	3,200		
E Ground clearance of rear end*	1,190		
F Ground clearance*	485		
G Tail swing radius	3,600		

Unit: mm

G'	Distance from centre of swing to rear end	3,600
H	Tumbler distance	4,050
I	Overall length of crawler	4,960
J Track gauge	SK350LC	2,590
	SK350NLC	2,390
K	Shoe width	600
L	Overall width of upperstructure	2,980

*Without including height of shoe lug

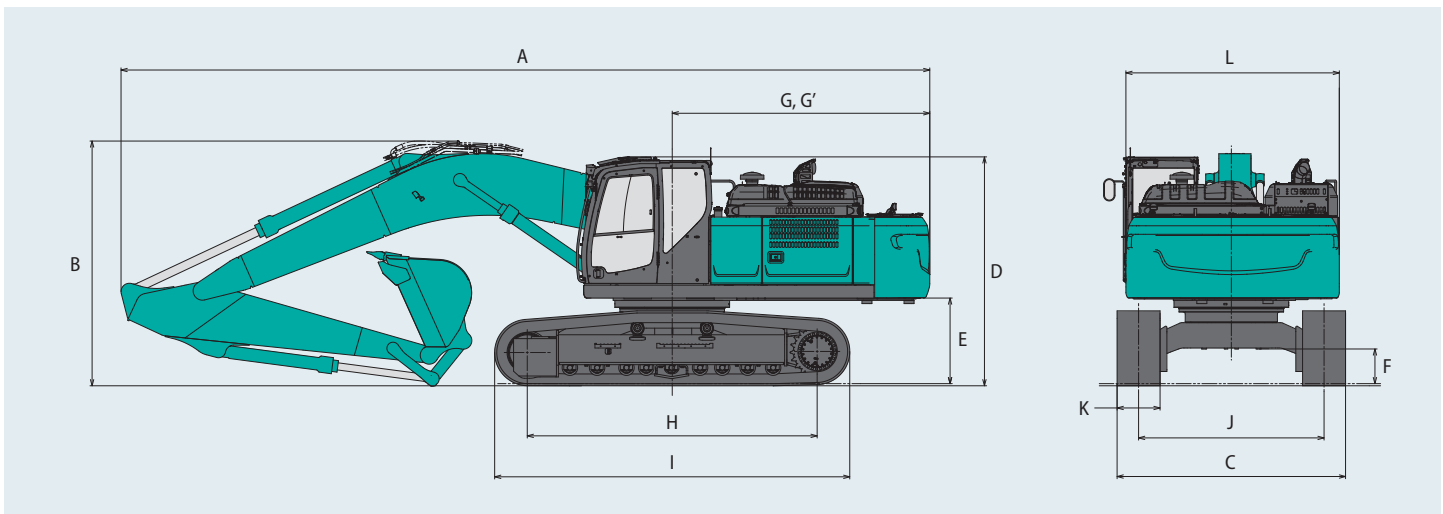

Operating weight & ground pressure

In standard trim, with standard boom, 3.30 m arm, and 1.40 m³ ISO heaped bucket

Shaped			Triple grouser shoes (even height)			
Shoe width	mm		600	700	800	900
Overall width of crawler	SK350LC	mm	3,190	3,290	3,390	3,490
	SK350NLC	mm	2,990	3,090	—	—
Ground pressure	SK350LC	kPa	69	61	54	48
	SK350NLC	kPa	69	60	—	—
Operating weight	SK350LC	kg	37,000	37,800	38,200	38,600
	SK350NLC	kg	36,900	37,700	—	—

Lift Capacities

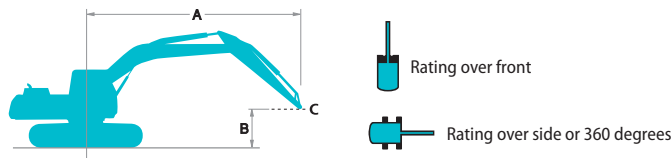





























A: Reach from swing centreline to arm top
 B: Arm top height above/below ground
 C: Lift point
 Bucket: Without bucket
 Relief valve setting: 37.8 MPa (385 kgf/cm²)











SK350LC		Boom: 6.50 m Arm: 3.30 m Bucket: without Shoe: 600 mm (Heavy Lift)															
B	A	1.5 m		3.0 m		4.5 m		6.0 m		7.5 m		9.0 m		At max. reach		Radius	
9.0 m	kg														*6,370	*6,370	6.56 m
7.5 m	kg									*7,810	*7,810				*5,840	*5,840	7.86 m
6.0 m	kg									*7,930	*7,930				*5,640	*5,640	8.71 m
4.5 m	kg								*9,720	*9,720	*8,490	7,700	*7,850	5,750	*5,650	5,480	9.25 m
3.0 m	kg					*15,090	*15,090	*11,160	10,160	*9,230	7,360	*8,160	5,600	*5,830	5,110	9.52 m	
1.5 m	kg					*17,300	14,250	*12,430	9,580	*9,940	7,040	8,400	5,430	*6,200	4,980	9.54 m	
G.L.	kg					*18,060	13,770	*13,170	9,200	*10,400	6,810	8,270	5,320	*6,830	5,070	9.33 m	
-1.5 m	kg			*15,390	*15,390	*17,700	13,670	*13,230	9,040	*10,420	6,700				*7,890	5,410	8.85 m
-3.0 m	kg	*17,520	*17,520	*22,280	*22,280	*16,380	13,810	*12,490	9,080	*9,690	6,750				*8,640	6,160	8.07 m
-4.5 m	kg			*18,200	*18,200	*13,800	*13,800	*10,490	9,330						*8,540	7,810	6.88 m

SK350LC		Boom: 6.50 m Arm: 4.15 m Bucket: without Shoe: 600 mm (Heavy Lift)															
B	A	1.5 m		3.0 m		4.5 m		6.0 m		7.5 m		9.0 m		At max. reach		Radius	
9.0 m	kg									*5,080	*5,080				*4,770	*4,770	7.56 m
7.5 m	kg														*4,460	*4,460	8.71 m
6.0 m	kg									*6,890	*6,890	*6,580	5,910	*4,350	*4,350	9.49 m	
4.5 m	kg									*7,520	*7,520	*6,990	5,760	*4,380	*4,380	9.98 m	
3.0 m	kg			*21,160	*21,160	*13,040	*13,040	*9,950	*9,950	*8,350	7,380	*7,420	5,550	*4,530	4,480	10.23 m	
1.5 m	kg					*15,760	14,500	*11,410	9,620	*9,190	6,990	*7,880	5,330	*4,820	4,350	10.25 m	
G.L.	kg			*10,820	*10,820	*17,290	13,670	*12,470	9,100	*9,850	6,670	8,120	5,150	*5,280	4,390	10.05 m	
-1.5 m	kg	*10,180	*10,180	*14,950	*14,950	*17,630	13,340	*12,920	8,810	*10,150	6,480	8,010	5,050	*6,040	4,620	9.62 m	
-3.0 m	kg	*14,870	*14,870	*20,400	*20,400	*16,950	13,330	*12,670	8,740	*9,910	6,430			*7,340	5,150	8.91 m	
-4.5 m	kg	*20,310	*20,310	*21,170	*21,170	*15,190	13,570	*11,490	8,870	*8,720	6,570			*8,060	6,210	7.85 m	
-6.0 m	kg			*15,790	*15,790	*11,710	*11,710	*8,510	*8,510					*7,910	*7,910	6.26 m	

SK350LC		Boom: 6.50 m Arm: 2.60 m Bucket: without Shoe: 600 mm (Heavy Lift)										
B	A	3.0 m		4.5 m		6.0 m		7.5 m		At max. reach		Radius
7.5 m	kg									*8,760	8,640	7.06 m
6.0 m	kg					*9,360	*9,360	*8,610	7,750	*8,540	6,930	8.00 m
4.5 m	kg			*13,460	*13,460	*10,470	*10,470	*9,030	7,510	*8,510	6,060	8.58 m
3.0 m	kg					*11,770	9,860	*9,650	7,200	*8,600	5,610	8.87 m
1.5 m	kg					*12,800	9,350	*10,200	6,920	8,480	5,460	8.89 m
G.L.	kg			*17,830	13,610	*13,230	9,070	*10,460	6,740	8,720	5,590	8.66 m
-1.5 m	kg			*16,930	13,660	*12,940	9,000	*10,170	6,700	*9,090	6,050	8.15 m
-3.0 m	kg	*19,180	*19,180	*15,120	13,900	*11,730	9,140			*9,110	7,120	7.29 m
-4.5 m	kg	*14,570	*14,570	*11,740	*11,740					*8,590	*8,590	5.95 m

SK350NLC		Boom: 6.50 m Arm: 3.30 m Bucket: without Shoe: 600 mm (Heavy Lift)															
B \ A	1.5 m		3.0 m		4.5 m		6.0 m		7.5 m		9.0 m		At max. reach		Radius		
																	
9.0 m	kg														*6,370	*6,370	6.56 m
7.5 m	kg									*7,810	7,500				*5,840	*5,840	7.86 m
6.0 m	kg									*7,930	7,400				*5,640	*5,640	8.71 m
4.5 m	kg							*9,720	*9,720	*8,490	7,140	*7,850	5,320	*5,650	5,070	9.25 m	
3.0 m	kg					*15,090	14,020	*11,160	9,360	*9,230	6,800	*8,160	5,170	*5,830	4,720	9.52 m	
1.5 m	kg					*17,300	12,960	*12,430	8,800	*9,940	6,490	8,370	5,010	*6,200	4,590	9.54 m	
G.L.	kg					*18,060	12,500	*13,170	8,430	*10,400	6,260	8,240	4,890	*6,830	4,660	9.33 m	
-1.5 m	kg			*15,390	*15,390	*17,700	12,400	*13,230	8,270	*10,420	6,150			*7,890	4,980	8.85 m	
-3.0 m	kg	*17,520	*17,520	*22,280	*22,280	*16,380	12,530	*12,490	8,310	*9,690	6,200			*8,640	5,670	8.07 m	
-4.5 m	kg			*18,200	*18,200	*13,800	12,880	*10,490	8,560					*8,540	7,190	6.88 m	

SK350NLC		Boom: 6.50 m Arm: 4.15 m Bucket: without Shoe: 600 mm (Heavy Lift)															
B \ A	1.5 m		3.0 m		4.5 m		6.0 m		7.5 m		9.0 m		At max. reach		Radius		
																	
9.0 m	kg									*5,080	*5,080				*4,770	*4,770	7.56 m
7.5 m	kg														*4,460	*4,460	8.71 m
6.0 m	kg									*6,890	*6,890	*6,580	5,470	*4,350	*4,350	9.49 m	
4.5 m	kg									*7,520	7,210	*6,990	5,330	*4,380	*4,380	9.98 m	
3.0 m	kg			*21,160	*21,160	*13,040	*13,040	*9,950	9,520	*8,350	6,820	*7,420	5,120	*4,530	4,120	10.23 m	
1.5 m	kg					*15,760	13,190	*11,410	8,830	*9,190	6,430	*7,880	4,900	*4,820	3,990	10.25 m	
G.L.	kg			*10,820	*10,820	*17,290	12,390	*12,470	8,320	*9,850	6,120	8,100	4,730	*5,280	4,020	10.05 m	
-1.5 m	kg	*10,180	*10,180	*14,950	*14,950	*17,630	12,070	*12,920	8,040	*10,150	5,930	7,990	4,630	*6,040	4,230	9.62 m	
-3.0 m	kg	*14,870	*14,870	*20,400	*20,400	*16,950	12,060	*12,670	7,970	*9,910	5,890			*7,340	4,720	8.91 m	
-4.5 m	kg	*20,310	*20,310	*21,170	*21,170	*15,190	12,290	*11,490	8,100	*8,720	6,020			*8,060	5,700	7.85 m	
-6.0 m	kg			*15,790	*15,790	*11,710	*11,710	*8,510	*8,510					*7,910	*7,910	6.26 m	

SK350NLC		Boom: 6.50 m Arm: 2.60 m Bucket: without Shoe: 600 mm (Heavy Lift)										
B \ A	3.0 m		4.5 m		6.0 m		7.5 m		At max. reach		Radius	
												
7.5 m	kg									*8,760	8,010	7.06 m
6.0 m	kg					*9,360	*9,360	*8,610	7,190	*8,540	6,420	8.00 m
4.5 m	kg			*13,460	*13,460	*10,470	9,700	*9,030	6,950	*8,510	5,600	8.58 m
3.0 m	kg					*11,770	9,070	*9,650	6,640	*8,600	5,180	8.87 m
1.5 m	kg					*12,800	8,570	*10,200	6,360	8,450	5,030	8.89 m
G.L.	kg			*17,830	12,340	*13,230	8,290	*10,460	6,190	8,690	5,140	8.66 m
-1.5 m	kg			*16,930	12,390	*12,940	8,230	*10,170	6,160	*9,090	5,570	8.15 m
-3.0 m	kg	*19,180	*19,180	*15,120	12,620	*11,730	8,370			*9,110	6,540	7.29 m
-4.5 m	kg	*14,570	*14,570	*11,740	*11,740					*8,590	*8,590	5.95 m

Notes:

- Do not attempt to lift or hold any load that is greater than these lift capacities at their specified lift point radius and heights. Weight of all accessories must be deducted from the above lift capacities.
- Lift capacities are based on machine standing on level, firm, and uniform ground. User must make allowance for job conditions such as soft or uneven ground, out of level conditions, side loads, sudden stopping of loads, hazardous conditions, experience of personnel, etc.
- Arm top defined as lift point.
- The above lift capacities are in compliance with ISO 10567. They do not exceed 87% of hydraulic lift

capacity or 75% of tipping load. Lift capacities marked with an asterisk(*) are limited by hydraulic capacity rather than tipping load.

- Operator should be fully acquainted with the Operator's and Maintenance Instructions before operating this machine. Rules for safe operation of equipment should be adhered to at all times.
- Lift capacities apply to only machine as originally manufactured and normally equipped by KOBELCO CONSTRUCTION MACHINERY CO., LTD.

2 Piece Boom Specifications



Working Ranges

Unit: mm

Range	Arm	2 Piece Boom		
		Short 2.60 m	Standard 3.30 m	Long 4.15 m
a- Max. digging reach		10,680	11,350	12,110
b- Max. digging reach at ground level		10,480	11,160	11,930
c- Max. digging depth		6,510	7,200	8,010
d- Max. digging height		12,090	12,650	13,180
e- Max. dumping clearance		8,720	9,280	9,800
f- Min. dumping clearance		820	120	730
g- Max. vertical wall digging depth		3,920	4,460	5,280
h- Min. swing radius		3,310	3,000	3,140
i- Horizontal digging stroke at ground level		6,670	8,030	9,630
j- Digging depth for 2.4 m (8') flat bottom		6,410	7,110	7,920
Bucket capacity ISO heaped m ³		1.60	1.40	1.20

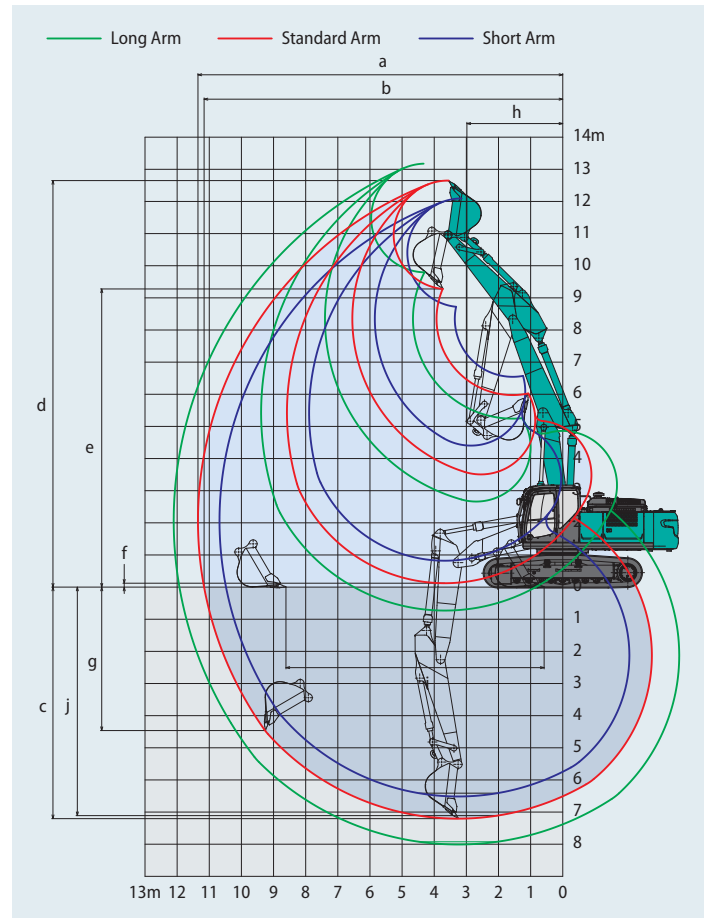

Digging Force (ISO 6015)

Unit: kN

Arm length	Short 2.60 m	Standard 3.30 m	Long 4.15 m
Bucket digging force	221 243*	222 244*	222 242*
Arm crowding force	205 225*	163 180*	140 154*

*Power Boost engaged.



Dimensions

Arm length	Short 2.60 m	Standard 3.30 m	Long 4.15 m
A Overall length	11,290	11,270	11,270
B Overall height (to top of boom)	3,420	3,360	3,670
C Overall width of crawler	SK350LC	3,190	
	SK350NLC	2,990	
D Overall height (to top of cab)	3,210		
E Ground clearance of rear end*	1,190		
F Ground clearance*	485		
G Tail swing radius	3,600		

Unit: mm

G'	Distance from centre of swing to rear end	3,600	
H	Tumbler distance	4,050	
I	Overall length of crawler	4,960	
J	Track gauge	SK350LC	2,590
		SK350NLC	2,390
K	Shoe width	600	
L	Overall width of upperstructure	2,980	

*Without including height of shoe lug

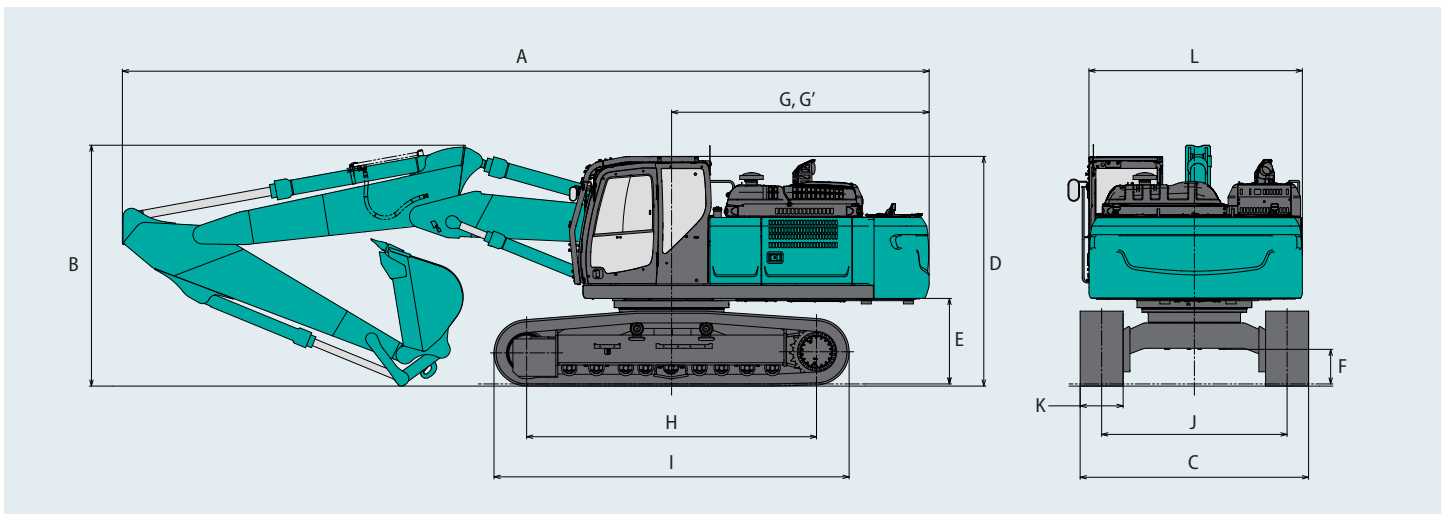

Operating weight & ground pressure

SK350_{LC}
SK350LC-11E

SK350_{NLC}
SK350NLC-11E

In standard trim, with 2 piece boom, 3.30 m arm, and 1.40 m³ ISO heaped bucket

Shaped			Triple grouser shoes (even height)			
Shoe width	mm		600	700	800	900
Overall width of crawler	SK350LC	mm	3,190	3,290	3,390	3,490
	SK350NLC	mm	2,990	3,090	—	—
Ground pressure	SK350LC	kPa	71	62	55	49
	SK350NLC	kPa	71	62	—	—
Operating weight	SK350LC	kg	37,800	38,700	39,100	39,500
	SK350NLC	kg	37,700	38,600	—	—

Lift Capacities

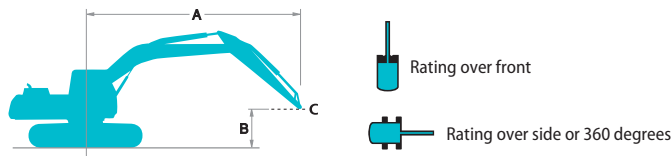













A: Reach from swing centreline to arm top
 B: Arm top height above/below ground
 C: Lift point
 Bucket: Without bucket
 Relief valve setting: 37.8 MPa (385 kgf/cm²)













SK350LC		2 piece boom		Arm: 3.30 m		Bucket: without		Shoe: 600 mm (Heavy Lift)						
B	A	3.0 m		4.5 m		6.0 m		7.5 m		9.0 m		At max. reach		Radius
10.5 m	kg			*9,280	*9,280							*8,430	*8,430	4.63 m
9.0 m	kg					*7,950	*7,950					*6,880	*6,880	6.70 m
7.5 m	kg					*11,010	*11,010	*6,790	*6,790			*6,000	*6,000	7.98 m
6.0 m	kg			*11,880	*11,880	*11,440	11,290	*5,780	*5,780			*5,700	*5,700	8.82 m
4.5 m	kg			*15,800	*15,800	*12,220	10,710	*5,090	*5,090	*6,010	5,640	*5,610	5,270	9.35 m
3.0 m	kg	*25,710	*25,710	*17,600	15,170	*13,010	10,020	*4,970	*4,970	*6,110	5,500	*5,690	4,940	9.61 m
1.5 m	kg	*27,810	27,660	*18,080	14,060	*13,350	9,430	*5,520	*5,520	*6,410	5,340	*5,950	4,830	9.64 m
G.L.	kg	*22,850	*22,850	*16,900	13,610	*12,910	9,070	*6,850	6,710	*6,790	5,240	*6,410	4,940	9.43 m
-1.5 m	kg	*13,570	*13,570	*14,510	13,560	*11,540	8,950	*8,730	6,620			*6,210	5,300	8.96 m
-3.0 m	kg			*11,000	*11,000	*9,050	9,030	*6,670	*6,670			*4,980	*4,980	8.19 m











SK350LC		2 piece boom		Arm: 4.15 m		Bucket: without		Shoe: 600 mm (Heavy Lift)						
B	A	3.0 m		4.5 m		6.0 m		7.5 m		9.0 m		At max. reach		Radius
10.5 m	kg					*6,110	*6,110					*5,800	*5,800	6.06 m
9.0 m	kg					*8,460	*8,460	*6,160	*6,160			*4,930	*4,930	7.75 m
7.5 m	kg					*8,600	*8,600	*5,270	*5,270			*4,530	*4,530	8.88 m
6.0 m	kg					*9,190	*9,190	*9,070	7,990	*5,200	*5,200	*4,360	*4,360	9.64 m
4.5 m	kg			*11,810	*11,810	*11,270	10,960	*9,470	7,670	*4,880	*4,880	*4,320	*4,320	10.13 m
3.0 m	kg	*24,380	*24,380	*16,330	15,760	*12,240	10,190	*9,920	7,260	*4,820	*4,820	*4,400	4,270	10.37 m
1.5 m	kg	*27,360	*27,360	*17,650	14,310	*12,910	9,470	*3,820	*3,820	*5,140	*5,140	*4,600	4,170	10.39 m
G.L.	kg	*9,090	*9,090	*17,460	13,490	*12,930	8,960	*4,950	*4,950	*5,820	5,060	*4,950	4,230	10.20 m
-1.5 m	kg	*13,370	*13,370	*15,870	13,200	*12,100	8,700	*6,810	6,390	*6,560	4,980	*5,530	4,480	9.77 m
-3.0 m	kg	*16,040	*16,040	*13,080	*13,080	*10,290	8,660	*7,910	6,370	*5,260	5,050	*5,080	5,010	9.07 m
-4.5 m	kg			*8,930	*8,930	*7,180	*7,180	*4,900	*4,900			*3,650	*3,650	8.03 m

SK350LC		2 piece boom		Arm: 2.60 m		Bucket: without		Shoe: 600 mm (Heavy Lift)					
B	A	3.0 m		4.5 m		6.0 m		7.5 m		At max. reach		Radius	
9.0 m	kg			*14,100	*14,100					*11,940	*11,940	5.68 m	
7.5 m	kg			*14,020	*14,020	*7,550	*7,550			*10,480	8,290	7.15 m	
6.0 m	kg	*17,220	*17,220	*15,020	*15,020	*12,050	10,970	*7,170	*7,170	*9,750	6,690	8.08 m	
4.5 m	kg	*18,730	*18,730	*16,730	15,980	*12,700	10,380	*6,530	*6,530	9,100	5,860	8.65 m	
3.0 m	kg	*24,140	*24,140	*17,580	14,830	*13,250	9,730	*6,440	*6,440	8,520	5,460	8.94 m	
1.5 m	kg	*27,960	*27,960	*17,980	13,920	*13,240	9,220	*7,090	6,820	*8,050	5,330	8.97 m	
G.L.	kg	*25,280	*25,280	*15,550	13,550	*7,760	*7,760	*8,460	6,660	*7,370	5,480	8.74 m	
-1.5 m	kg	*13,790	*13,790	*12,520	*12,520	*10,510	8,940	*8,040	6,660	*6,360	5,980	8.23 m	
-3.0 m	kg			*8,540	*8,540	*7,370	*7,370			*4,620	*4,620	7.38 m	

Lift capacities

SK350NLC		2 piece boom		Arm: 3.30 m		Bucket: without		Shoe: 600 mm (Heavy Lift)						
B	A	3.0 m		4.5 m		6.0 m		7.5 m		9.0 m		At max. reach		Radius
														
10.5 m	kg			*9,280	*9,280							*8,430	*8,430	4.63 m
9.0 m	kg					*7,950	*7,950					*6,880	*6,880	6.70 m
7.5 m	kg					*11,010	10,790	*6,790	*6,790			*6,000	*6,000	7.98 m
6.0 m	kg			*11,880	*11,880	*11,440	10,460	*5,780	*5,780			*5,700	5,450	8.82 m
4.5 m	kg			*15,800	15,320	*12,220	9,890	*5,090	*5,090	*6,010	5,210	*5,610	4,860	9.35 m
3.0 m	kg	*25,710	*25,710	*17,600	13,830	*13,010	9,220	*4,970	*4,970	*6,110	5,060	*5,690	4,540	9.61 m
1.5 m	kg	*27,810	24,420	*18,080	12,760	*13,350	8,640	*5,520	*5,520	*6,410	4,910	*5,950	4,440	9.64 m
G.L.	kg	*22,850	*22,850	*16,900	12,320	*12,910	8,290	*6,850	6,150	*6,790	4,810	*6,410	4,530	9.43 m
-1.5 m	kg	*13,570	*13,570	*14,510	12,270	*11,540	8,160	*8,730	6,070			*6,210	4,870	8.96 m
-3.0 m	kg			*11,000	*11,000	*9,050	8,250	*6,670	6,160			*4,980	*4,980	8.19 m

SK350NLC		2 piece boom		Arm: 4.15 m		Bucket: without		Shoe: 600 mm (Heavy Lift)						
B	A	3.0 m		4.5 m		6.0 m		7.5 m		9.0 m		At max. reach		Radius
														
10.5 m	kg					*6,110	*6,110					*5,800	*5,800	6.06 m
9.0 m	kg					*8,460	*8,460	*6,160	*6,160			*4,930	*4,930	7.75 m
7.5 m	kg					*8,600	*8,600	*5,270	*5,270			*4,530	*4,530	8.88 m
6.0 m	kg					*9,190	*9,190	*9,070	7,400	*5,200	*5,200	*4,360	*4,360	9.64 m
4.5 m	kg			*11,810	*11,810	*11,270	10,130	*9,470	7,090	*4,880	*4,880	*4,320	4,180	10.13 m
3.0 m	kg	*24,380	*24,380	*16,330	14,390	*12,240	9,380	*9,920	6,690	*4,820	*4,820	*4,400	3,920	10.37 m
1.5 m	kg	*27,360	24,350	*17,650	12,990	*12,910	8,670	*3,820	*3,820	*5,140	4,790	*4,600	3,810	10.39 m
G.L.	kg	*9,090	*9,090	*17,460	12,190	*12,930	8,170	*4,950	*4,950	*5,820	4,630	*4,950	3,870	10.20 m
-1.5 m	kg	*13,370	*13,370	*15,870	11,910	*12,100	7,910	*6,810	5,830	*6,560	4,550	*5,530	4,100	9.77 m
-3.0 m	kg	*16,040	*16,040	*13,080	11,950	*10,290	7,880	*7,910	5,810	*5,260	4,620	*5,080	4,580	9.07 m
-4.5 m	kg			*8,930	*8,930	*7,180	*7,180	*4,900	*4,900			*3,650	*3,650	8.03 m

SK350NLC		2 piece boom		Arm: 2.60 m		Bucket: without		Shoe: 600 mm (Heavy Lift)					
B	A	3.0 m		4.5 m		6.0 m		7.5 m		At max. reach		Radius	
													
9.0 m	kg			*14,100	*14,100					*11,940	11,220	5.68 m	
7.5 m	kg			*14,020	*14,020	*7,550	*7,550			*10,480	7,670	7.15 m	
6.0 m	kg	*17,220	*17,220	*15,020	*15,020	*12,050	10,140	*7,170	7,070	*9,750	6,180	8.08 m	
4.5 m	kg	*18,730	*18,730	*16,730	14,610	*12,700	9,570	*6,530	*6,530	9,100	5,410	8.65 m	
3.0 m	kg	*24,140	*24,140	*17,580	13,500	*13,250	8,930	*6,440	*6,440	8,520	5,020	8.94 m	
1.5 m	kg	*27,960	25,050	*17,980	12,620	*13,240	8,430	*7,090	6,260	*8,050	4,900	8.97 m	
G.L.	kg	*25,280	24,320	*15,550	12,260	*7,760	*7,760	*8,460	6,100	*7,370	5,040	8.74 m	
-1.5 m	kg	*13,790	*13,790	*12,520	12,310	*10,510	8,160	*8,040	6,110	*6,360	5,490	8.23 m	
-3.0 m	kg			*8,540	*8,540	*7,370	*7,370			*4,620	*4,620	7.38 m	

Notes:

- Do not attempt to lift or hold any load that is greater than these lift capacities at their specified lift point radius and heights. Weight of all accessories must be deducted from the above lift capacities.
- Lift capacities are based on machine standing on level, firm, and uniform ground. User must make allowance for job conditions such as soft or uneven ground, out of level conditions, side loads, sudden stopping of loads, hazardous conditions, experience of personnel, etc.
- Arm top defined as lift point.
- The above lift capacities are in compliance with ISO 10567. They do not exceed 87% of hydraulic lift capacity or 75% of tipping load. Lift capacities marked with an asterisk (*) are limited by hydraulic capacity rather than tipping load.
- Operator should be fully acquainted with the Operator's and Maintenance Instructions before operating this machine. Rules for safe operation of equipment should be adhered to at all times.
- Lift capacities apply to only machine as originally manufactured and normally equipped by KOBELCO CONSTRUCTION MACHINERY CO., LTD.

Standard and Optional Equipment

SK350 LC
SK350LC-11E

SK350 NLC
SK350NLC-11E

● = Std ○ = Opt — = N/A

Category	Description	SK350LC/SK350NLC-11E	
		Mono boom / 2 Piece boom	
		LC	NLC
ENGINE	ISUZU 6HK1 (EU Stage V compliant)	●	●
	Exhaust DOC DPF SCR system	●	●
	Alternator 24 V/90 A	●	●
	Starter motor 24 V/5 kW	●	●
	Batteries 2 x 12 V (140 Ah)	●	●
	Fan suction type cooling system	●	●
	Auto deceleration function	●	●
	Auto Idle Stop (AIS)	●	●
HYDRAULIC SYSTEM	3 work modes H,S,Eco	●	●
	Power boost (37.8 MPa)	●	●
	Heavy lift mode	●	●
	Pressure release function	●	●
	Independent travel function	●	●
	Auto warm up system	●	●
	Proportional Hand Control (for E&N&B piping)	●	●
	Hydraulic oil VG32	●	●
	Hydraulic oil VG46	○	○
	Hydraulic oil VG68	○	○
PIPING	E&N&B piping	●	●
	E&N&B piping + Bigger capacity P4 pump (84.9 L/min)	○	○
	Standard piping (only mono boom spec)	○	—
	QH piping	●	●
CABIN	Air suspension seat with heating	●	●
	10-inch colour monitor	●	●
	LED door light	●	●
	Air-conditioner	●	●
	DAB+ radio (FM/AM & AUX & USB & Bluetooth* & hands-free telephone)	●	●
	Harness for CAB four lights and CAB yellow flasher	●	●
	Parallel wiper	●	●
	12 V power outlet	●	●
	Rain visor	○	○
	Sun screen	●	●
LIGHTS	LED work lights ; 2 on boom, 1 on upper frame, 2 on rear counterweight	●	●
	LED work lights; 2 on Cab top front	○	○
WORKING EQUIPMENT	Standard Boom (6.50 m)	●	●
	2 Piece Boom	○	○
	Standard HD arm (3.30 m) with rock guard	●	●
	Short HD arm (2.60 m) with rock guard	○	○
	Long HD arm (4.15 m) with rock guard	○	○
	Bucket link with lifting hook	●	●
COUNTERWEIGHT	Semi heavier C/W (TTL 8,590 kg)	●	●
UNDERCARRIAGE	600 mm steel shoe	●	●
	600 mm double grouser shoe	○	○
	700 mm steel shoe	○	○
	800 mm steel shoe	○	—
	900 mm steel shoe	○	—
	Track guide (one per side)	●	●
	Additional track guides (two additional per side)	○	○
SAFETY	Lower frame guard	●	●
	Engine emergency stop switch	●	●
	Pump emergency mode (KPSS release switch)	●	●
	Emergency accel dial	●	●
	Emergency manual valve for lowering attachment	●	●
	Overload alarm	●	●
	Safety valve for boom & arm cylinder	●	●
	ROPS compliant CAB (ISO 12117-2:2008)	●	●
	OPG Level II top guard (ISO 10262:1998)	●	●
	OPG Level II front guard (ISO 10262:1998)	○	○
	Eagle-eye view camera (Rear, Right, Left)	●	●
	Seatbelt indicator on display	●	●
	Travel alarm	○	○
	Extended handrail	○	○
	Emergency escape hammer	●	●
OTHERS	Refuelling pump	●	●
	Harness for engine room light	●	●
	RAL color	○	○
	KOMEXS	●	●

*The air conditioning system on this machine contains fluorinated greenhouse gas HFC-134a (GWP 1430). Quantity of gas 0.9 kg (CO₂ equivalent 1.3 t).
Note: Bluetooth* is a registered trademark of the Bluetooth SIG Inc.

SK350 LC
SK350LC-11E

SK350 NLC
SK350NLC-11E

Note: This catalogue may contain attachments and optional equipment that are not available in your area. And it may contain photographs of machines with specifications that differ from those of machines sold in your areas. Please consult your nearest KOBELCO distributor for those items you require.
Specialist equipment is needed to use this machine in demolition work. Before using it please contact your KOBELCO dealer.
Due to our policy of continuous product improvements all designs and specifications are subject to change without advance notice.
Copyright by **KOBELCO CONSTRUCTION MACHINERY CO., LTD.** No part of this catalogue may be reproduced in any manner without notice.

KOBELCO CONSTRUCTION MACHINERY EUROPE B.V.

Veluwezoom 15
1327 AE Almere
The Netherlands
www.kobelco-europe.com

Enquiries To: