

KOBELCO

Performance  Design

SK520_{LC}

- Bucket capacity:
1.4 – 3.4 m³
- Engine power:
348 kW / 1,800 min⁻¹
- Operating weight:
52,900 – 57,200 kg



Complies with the EU Stage V
exhaust emission regulation

Built for Perfectionists™



Performance Design

SK520LC of KOBELCO has realised a completely new value by harmonising PERFORMANCE and DESIGN.

Performance enhancements offer greater efficiency and productivity along with increased power and speed.

Design improvements provide the ultimate in comfort and control.

KOBELCO refuses to compromise, creating machines that meet every challenge.



THE ULTIMATE IN SIMPLE DESIGN

In our pursuit of functional beauty and styling, we created an all new interior design focused with the operator in mind.

Jog Dial

This dial integrates multiple functions into a single, easy to use interface. Even with gloves on, the operator can make the adjustments they need.

LED Illumination

Dials and buttons are now backlit to provide a bright, clear view in any lighting condition.







UNFORGETTABLE COMFORT

Air suspension seat

A GRAMMER* seat is installed as standard equipment, which achieves excellent shock absorption and superior ride comfort.

*GRAMMER is trademark of GRAMMER AG, registered in Germany and other countries.

Multi Vent Air Conditioner

Cool air is blown from multiple outlets toward the operator's body for more comfortable operation.

Ergonomic Lever Angles

Operators can move levers horizontally without twisting their wrists, reducing fatigue.



New Hydraulic Control

Our newly upgraded hydraulic control system responds to shorter lever strokes than previous models, delivering swifter, more precise movement and improved lever operability.

LED Interior Light

Interior lights turn on and off automatically when the door is open or the ignition is turned to the OFF position. This ensures safe entry and exit in the dark.

Parallel wipers secure a wide field of view



KOBELCO



04:33



SETTING MENU



PICTURE OF CAMERA



CLOCK SETTING



SCREEN BRIGHTNESS



MAINTENANCE



CONSUMPTION



LANGUAGE SELECTION



PRESSURE RELEASE



SAFETY ON FULL DISPLAY

Standard 3 Sides Safety Camera System

Our high-resolution, large display shows right, left and rear side cameras together. Multiple display allows the operator to customize viewing needs to enhance operator awareness and jobsite safety.

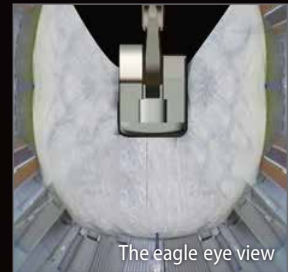
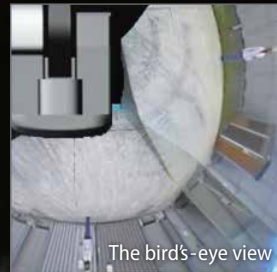
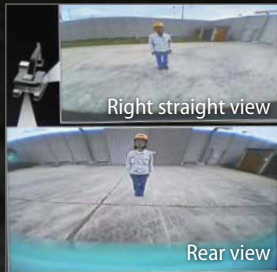

Large 10-Inch Color Monitor

The easy-to-operate menu screen and recognizable icons assist the operator to select the most important information needed to ensure jobsite safety and machine control.



Dial in the Right Information

Simply turn the jog dial to the right or left to select an operational feature, then press the dial to confirm selection.

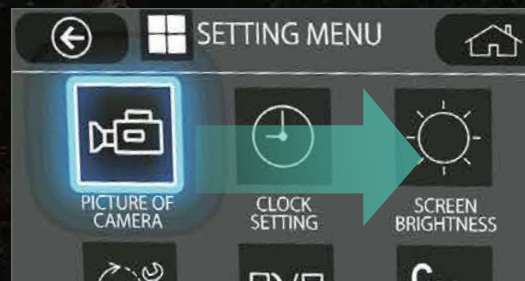



EXPERIENCING A COMPETENT PERFORMANCE

Excellent machine stability, plus an EU Stage V compliant engine

The new SK520LC is equipped with a Stage V compliant engine, which has a higher torque value. Superior balance between engine output and torque contributes to more efficient performance than the previous models. In addition, the DPF maintenance interval has been extended.



Model: ISUZU 6WG1

Engine output (Increased by 16%*)

348 kW / 1,800 min⁻¹

Independent Travel

Selecting Independent Travel dedicates one hydraulic pump to travel and one to the attachment on a continuous basis, allowing for a smooth and constant movement speed even while swinging or using the boom or attachment. With Independent Travel, safely carrying a large pipe across a job site is a breeze.

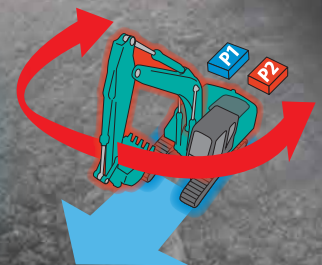

Max. bucket digging force (Increased by 10%*)

292 kN : Normal mode

321 kN : With Power Boost

Max. arm digging force (Increased by 9%*)

220 kN : Normal mode

242 kN : With Power Boost

(3.45 m arm)



Lifting Capacity (Increased by 12%*)

21,350 kg

(Reach: 6.0 m, Height: Ground level)

(Boom: 7.00 m, Arm: 3.45 m, Bucket: Without, Heavy Lift: ON)

*Comparison of SK500LC-11 at the same mode (Power Boost)

POWER PLANT DURABILITY YOU CAN TRUST

Enhanced body rigidity for 50-ton class machines

The SK520LC machines are widely used in mid-scale construction projects and harsh worksites. The components have been reviewed and improvements have been made to their durability to ensure stable performance in such environments.



Hydraulic drive for engine cooling / radiator fan; independent oil cooler fan

Hydraulic drive optimises the cooling fan rotation speed to improve fuel economy and reduce noise. Also, the independent oil cooler fan better matches cooling to the hydraulic oil temperature, for optimal oil temperature control.

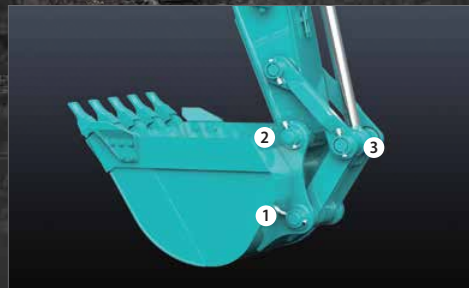

Larger bucket pin diameter

For tough work, the pins have been made thicker to increase durability.

STD: ① ② ③ / ME: ① ②

CONVENIENT AND SENSIBLE EQUIPMENT



Engine start password

A password is required when starting the engine for greater security.



Wiper adjustment function

In addition to the intermittent wiper mode and continuous wiper mode, the one-time wiper mode was added.



Parallel wiper

Sun screen (Option)



Console mount

The console-integrated seat allows for comfortable operation.



DAB+ radio (FM/AM & AUX & USB & Bluetooth® & hands-free telephone)



USB port/12V power outlet



Smartphone holder

You can use the holder with your smartphone connected to the USB port.

GREATER MULTI-FUNCTION CAPABILITIES

Attachment mode selection

The auxiliary flow rates for the bucket, breaker, nibbler, and rotating are all now adjustable by the operator through the monitor, allowing you to change tools quickly and easily. Mode settings for other attachments like the tilt rotator can be added or changed.



EASY MAINTENANCE



Cooling system components

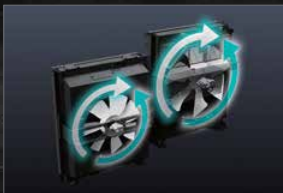

Reversible fan

With the flip of a switch from the drivers seat, the standard feature reversing fan pulls air in the opposite direction, blowing debris away to prevent clogging.



DEF/AdBlue[®] Tank



Standard Overhead Top Guard Level II

The standard overhead cab guard can be tilted open for easy window cleaning.

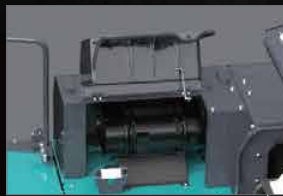

Air Filter

The greatly increased filtering capacity reduces clogging and extends reserve power and reliability.



Engine maintenance

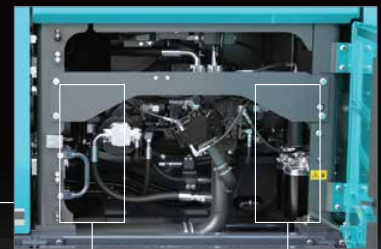

Fuel Filter / Pre-Filter with Integrated Water Separator



Engine Oil Filter

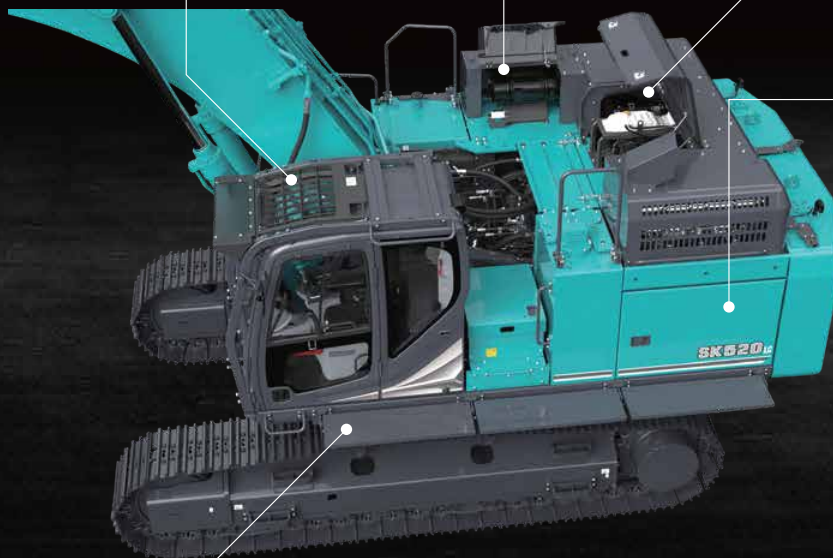

Standard left walkway

Easy access to the upper structure from the left walkway, without having to go down to the ground.

Note: AdBlue[®] is a registered trademark of the Verband der Automobilindustrie e.V. (VDA).



KOBELCO MONITORING EXCAVATOR SYSTEM

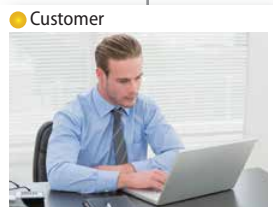

Remote Monitoring for Peace of Mind

KOMEXS (Kobelco Monitoring Excavator System) uses satellite communication and internet to relay data, and therefore can be deployed in areas where other forms of communication are difficult. When a hydraulic excavator is fitted with this system, data on the machine's operation, such as operating hours, location, fuel consumption, and maintenance status can be obtained remotely.

Direct Access to Operational Status

Location Data

Accurate location data can be obtained even from sites where communications are difficult.

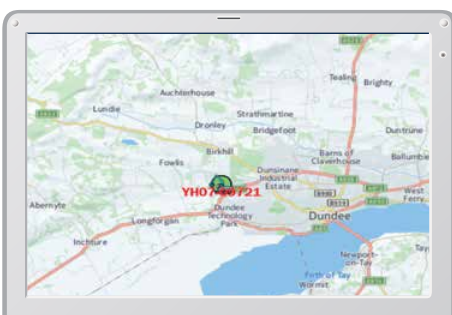

Latest location

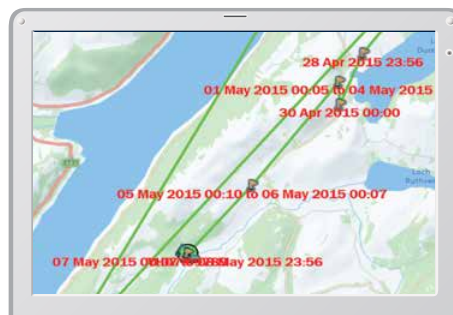

Location records

Type of Operation	Working Hrs	Ratio
Total Working Hrs	169 Hrs	100 %
Digging Hrs	72.2 Hrs	43 %
Traveling Hrs	18.3 Hrs	11 %
Idle Hrs	15.9 Hrs	9 %
Opt Att Hrs	62.5 Hrs	37 %
Crane Mode Hrs	0 Hrs	0 %

Work data

Operating Hours

- A comparison of operating times of machines at multiple locations shows which locations are busier and more profitable.
- Operating hours on site can be accurately recorded, for running time calculations needed for rental machines, etc.

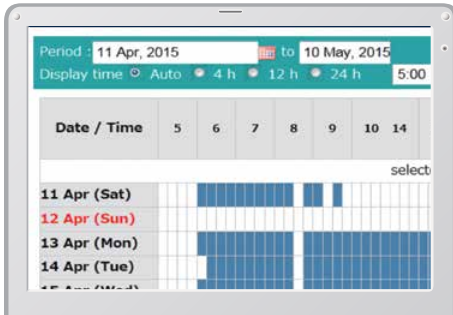

Daily report

Fuel Consumption Data

Data on fuel consumption and idling times can be used to indicate improvements in fuel consumption.

Work mode	Working Hrs	Total Fuel Consumption
H mode	2:06	24.5 L
S mode	0:00	0.0 L
E mode	169:19	1489.7 L
TOTAL	171:25	1514.2 L

Fuel consumption

Graph of Work Content

The graph shows how working hours are divided among different operating categories, including digging, idling, travelling and optional operations.

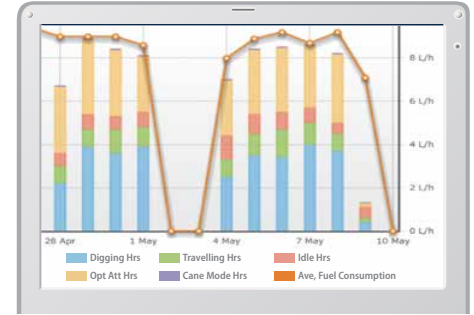

Work status

Maintenance Data and Warning Alerts

Machine Maintenance Data

- Provides maintenance status of separate machines operating at multiple sites.
- Maintenance data is also relayed to KOBELCO service personnel, for more efficient planning of periodic servicing.

Model	Serial No.	Hour Meter	Engine Oil
SK135SRLC-3/SK140SRL	YH07-09721 0.38/0.35	734 Hr	434
SK135SRLC-3/SK140SRL	YH07-09789 0.38/0.35	73 Hr	429
SK210LC-9	YQ13-10454 0.8/0.7	960 Hr	58
SK210LC-9	YQ13-10481 0.8/0.7	549 Hr	498
SK75SR-	YT08-30374		

Maintenance

Warning Alerts

This system warns an alert if an anomaly is sensed, preventing damage that could result in machine downtime.

Alarm Information Can Be Received through E-mail

Alarm information or maintenance notice can be received through E-mail, using a computer or cell phone.



Alarm messages can be received on mobile device.

Daily/Monthly Reports

Operational data downloaded onto a computer helps in formulating daily and monthly reports.

Security System

Engine Start Alarm

The system can be set an alarm if the machine is operated outside designated time.

Setting Condition

Setting Condition Change

Start time 20 : 00

Release time 07 : 00

No Working Whole Day

Mon Tue Wed Thu Fri Sat Sun

Clear

Engine start alarm outside prescribed work time

Area Alarm

It can be set an alarm if the machine is moved out of its designated area to another location.

Setting Condition

Around the current (latest) location 1 Km

Input Latitude and Longitude

Latitude1

Longitude1

Latitude2

Longitude2

Map Clear

Release

Alarm for outside of reset area

Specifications



Engine

Model	ISUZU 6WG1
Type	Direct injection, water-cooled, 4-cycle diesel engine with turbocharger, intercooler complies with EU Stage V exhaust emission regulation.
No. of cylinders	6
Bore and stroke	147 mm x 154 mm
Displacement	15.681 L
Rated power output	348 kW/1,800 min ⁻¹ (ISO 14396: without fan)
Max. torque	2,050 N.m/1,300 min ⁻¹ (ISO 14396: without fan)



Hydraulic System

Pump	
Type	Axial piston pumps + rotation gear pump + pilot gear pump
Max. discharge flow	2 x 370 L/min, 1 x 58.5, 1 x 27 L/min
Relief valve setting	
Boom, arm and bucket	34.3 MPa {350 kgf/cm ² }
Power Boost	37.8 MPa {385 kgf/cm ² }
Travel circuit	34.3 MPa {350 kgf/cm ² }
Swing circuit	26.0 MPa {265 kgf/cm ² }
Control circuit	5.0 MPa {51 kgf/cm ² }
Pilot control pump	Gear type
Main control valve	8-spool
Oil cooler	Air cooled type



Swing System

Swing motor	Two fixed displacement piston motor
Brake	Hydraulic; locking automatically when the swing control lever is in the neutral position
Parking brake	Oil disc brake, hydraulic operated automatically
Swing speed	7.5 min ⁻¹
Swing torque	188 kN-m



Attachments

Backhoe bucket and combination

Use		Backhoe bucket						
		Normal digging			Light-duty		Mass excavating	
Bucket capacity	ISO heaped	m ³	1.4	1.6	1.9	2.1	2.4	3.4
Struck		m ³	1.0	1.15	1.4	1.5	1.7	2.9
Opening width	With side cutter	mm	1,225	1,375	1,670	1,750	1,980	1,990
	Without side cutter	mm	1,100	1,250	1,550	1,620	1,850	1,870
No. of teeth			4	4	5	5	5	6
Bucket weight		kg	1,250	1,310	1,510	1,560	1,690	2,340
Combination	3.00 m short arm		○	○	○	◎	△	×
	3.45 m standard arm		○	○	◎	△	×	×
	4.04 m long arm		○	◎	△	×	×	×
	6.50 m ME boom and 2.60 m arm		×	×	×	×	×	○*

◎ Standard ○ Recommended △ Loading only × Not recommended

*ME arm specs should be used for light-digging.



Travel System

Travel motors	2 x axial-piston, two-step motors	
Travel brakes	Hydraulic brake per motor	
Parking brakes	Oil disc brake per motor	
Travel shoes	50 each side	
Travel speed	5.4/3.2 km/h	
Drawbar pulling force	Standard	411 kN (SAE)
	Mass excavation	409 kN (SAE)
Gradeability	70% {35°}	



Cab and control

Cab	
All-weather, sound-suppressed steel cab mounted on the high suspension mounts filled with silicone oil and equipped with a heavy, insulated floor mat	
Control	
Two hand levers and two foot pedals for travel	
Two hand levers for excavating and swing	
Electric rotary-type engine throttle	
Noise levels	
External	106 dB(A) (2000/14/EC)
Operator	72 dB(A) (ISO 6396)
Vibration levels	
Hand/arm*	≤ 2.5 m/s ²
Body*	≤ 0.5 m/s ²

*For the risk assessment according to 2002/44/EC, refer to ISO/TR 25398: 2006.



Boom, Arm and bucket

Boom cylinders	170 mm x 1,584 mm
Arm cylinder	190 mm x 1,990 mm
Bucket cylinder	160 mm x 1,410 mm
ME bucket cylinder	170 mm x 1,429 mm



Refilling Capacities and lubrications

Fuel tank	720 L
Cooling system	69 L
Engine oil	52 L
Travel reduction gear	2 x 15.0 L
Swing reduction gear	2 x 5.0 L
Hydraulic oil tank	370 L tank oil level
	803 L hydraulic system
DEF/Urea tank	83 L



Working Ranges

Unit: mm

Boom	6.50 m ME		7.00 m	
	ME 2.60 m	Short 3.00 m	Standard 3.45 m	Long 4.04 m
a- Max. digging reach	11,320	11,730	12,070	12,510
b- Max. digging reach at ground level	11,090	11,500	11,850	12,300
c- Max. digging depth	6,910	7,320	7,770	8,360
d- Max. digging height	10,960	11,050	10,980	10,870
e- Max. dumping clearance	7,100	7,630	7,620	7,580
f- Min. dumping clearance	2,970	3,240	2,790	2,200
g- Max. vertical wall digging depth	6,030	6,630	7,070	7,130
h- Min. swing radius	5,100	5,330	5,210	5,290
i- Horizontal digging stroke at ground level	3,860	5,110	6,050	6,930
j- Digging depth for 2.4 m (8') flat bottom	6,750	7,160	7,620	8,230
Bucket capacity ISO heaped m ³	3.4	2.1	1.9	1.6

Digging Force (ISO 6015)

Unit: kN

Arm length	ME 2.60 m	Short 3.00 m	Standard 3.45 m	Long 4.04 m
Bucket digging force	304 334*	293 322*	292 321*	288 317*
Arm crowding force	269 296*	245 270*	220 242*	200 219*

*Power Boost engaged.

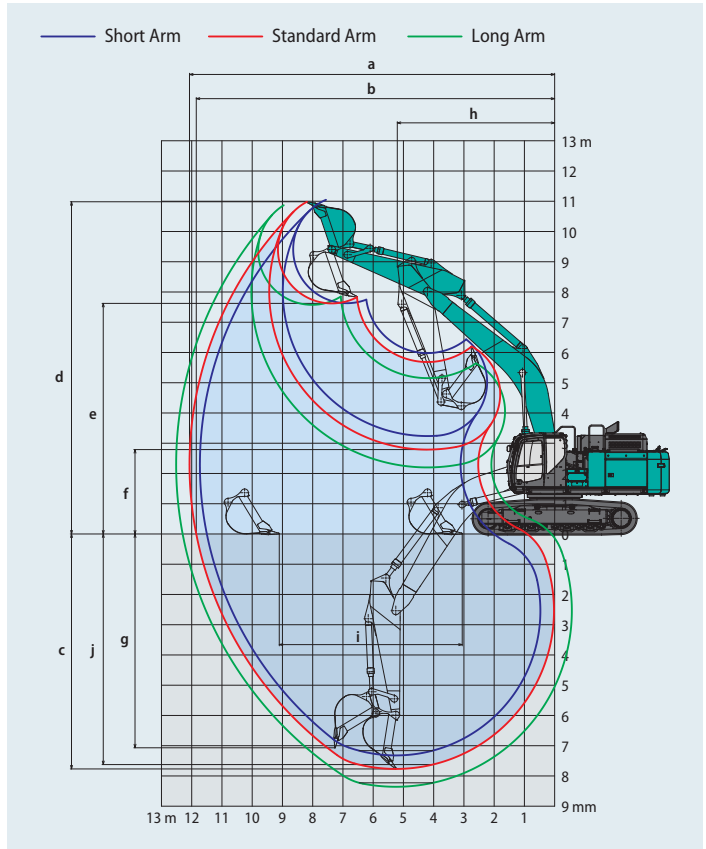

Unit: mm



Dimensions

Arm length	ME 2.60 m	Short 3.00 m	Standard 3.45 m	Long 4.04 m
A Overall length	12,120	12,210	12,160	12,260
B Overall height (to top of boom)	4,330	3,860	3,670	3,800
C Overall width (with step & walkway)		3,830		
C' Overall width (transport**)		3,460		
D Overall height (top of cab)		3,380		
D' Overall height (top of handrail)		3,640		
D'' Overall height (top of exhaust pipe)		3,740		
E Ground clearance of rear end*		1,260		
F Ground clearance*		510		
G Tail swing radius		3,880		

G'	Distance from center of swing to rear end	3,790
H	Tumbler distance	4,400
I	Overall length of crawler	5,460
J	Track gauge	2,750
K	Shoe width	600
L	Overall width of upperstructure	3,660
L'	Overall width of upperstructure (walkway folded)	3,400
M	Overall width of undercarriage (without steps)	3,350
M'	Overall width of undercarriage (with steps)	3,580

*without including height of shoe lug **without steps, walkway folded

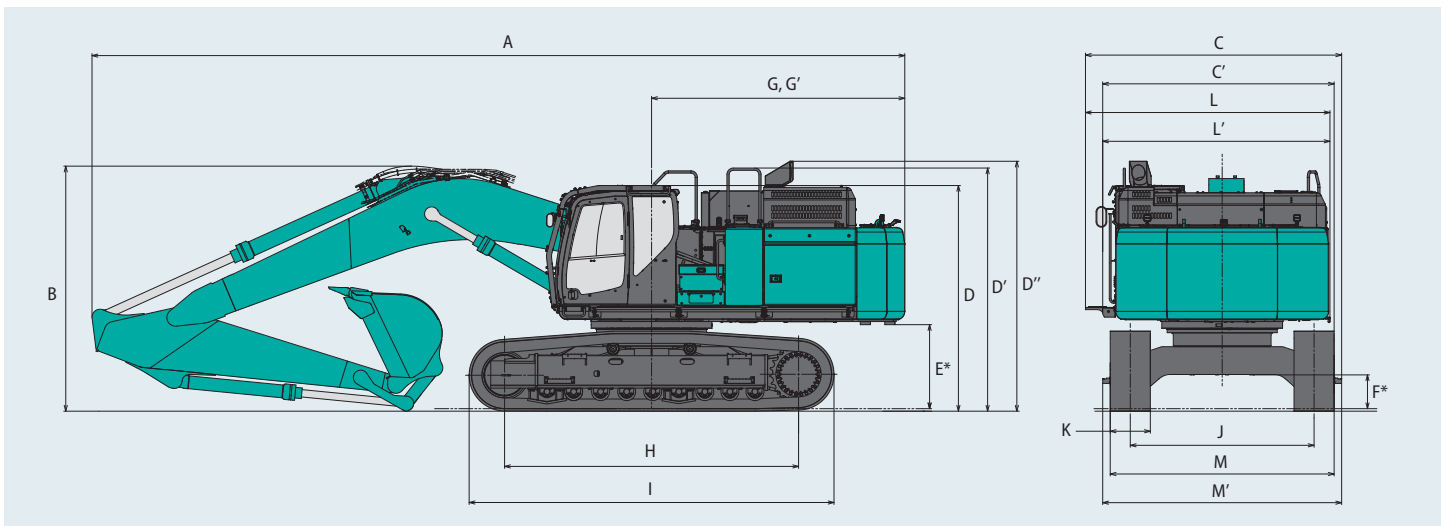

Operating weight and ground pressure

In standard trim, with standard boom, 3.45 m arm, 1.9 m³ ISO heaped bucket and standard counterweight.

Shaped		Triple grouser shoes				Double grouser shoes
Shoe width	mm	600	600 (HD)	800	900	600 (HD)
Overall width of crawler	mm	3,350	3,350	3,550	3,650	3,350
Ground pressure	kPa	90.6	91.0	69.8	62.6	90.8
Operating weight	kg	52,900	53,100	54,300	54,800	53,000

In standard trim, with standard boom, 4.04 m arm, 1.6 m³ ISO heaped bucket and standard counterweight.

Shaped		Triple grouser shoes				Double grouser shoes
Shoe width	mm	600	600 (HD)	800	900	600 (HD)
Overall width of crawler	mm	3,350	3,350	3,550	3,650	3,350
Ground pressure	kPa	91.0	91.3	69.9	62.8	91.0
Operating weight	kg	53,100	53,300	54,400	55,000	53,100

In standard trim, with standard boom, 3.00 m arm, 2.1 m³ ISO heaped bucket and standard counterweight.

Shaped		Triple grouser shoes				Double grouser shoes
Shoe width	mm	600	600 (HD)	800	900	600 (HD)
Overall width of crawler	mm	3,350	3,350	3,550	3,650	3,350
Ground pressure	kPa	90.8	91.3	69.9	62.8	91.0
Operating weight	kg	53,000	53,300	54,400	55,000	53,100

In standard trim, ME boom, 2.60m ME arm, 3.4 m³ ISO heaped bucket and heavier counterweight.

Shaped		Triple grouser shoes				Double grouser shoes
Shoe width	mm	600	600 (HD)	800	900	600 (HD)
Overall width of crawler	mm	3,350	3,350	3,550	3,650	3,350
Ground pressure	kPa	94.8	95.1	72.7	65.3	94.8
Operating weight	kg	55,300	55,500	56,600	57,200	55,300

Lift capacities

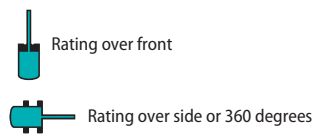
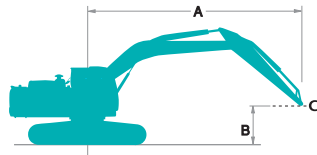

A - Reach from swing centerline to arm top
 B - Arm top height above/below ground
 C - Lift point
 Relief valve setting: 37.8 MPa (385 kgf/cm²)

SK520LC		Boom: 7.00 m Arm: 3.45 m Bucket: without Counterweight: 9,800 kg Shoe: 600 mm (Heavy Lift)												
B	A	3.0 m		4.5 m		6.0 m		7.5 m		9.0 m		At max. reach		Radius
		Rating over front	Rating over side or 360 degrees	Rating over front	Rating over side or 360 degrees	Rating over front	Rating over side or 360 degrees	Rating over front	Rating over side or 360 degrees	Rating over front	Rating over side or 360 degrees	Rating over front	Rating over side or 360 degrees	
9.0 m	kg											*9,110	*9,110	7.77 m
7.5 m	kg											*8,580	*8,580	8.87 m
6.0 m	kg							*12,630	12,410	*11,830	9,250	*8,410	8,270	9.60 m
4.5 m	kg			*21,340	*21,340	*16,300	*16,300	*13,760	11,900	*12,320	9,010	*8,470	7,530	10.05 m
3.0 m	kg			*26,240	23,260	*18,670	15,530	*15,050	11,340	*12,980	8,720	*8,750	7,130	10.27 m
1.5 m	kg			*20,240	*20,240	*20,500	14,710	*16,140	10,860	13,540	8,440	*9,290	7,010	10.25 m
G.L.	kg			*23,400	21,540	*21,350	14,240	*16,770	10,530	13,330	8,250	*10,170	7,160	10.02 m
-1.5 m	kg	*17,200	*17,200	*27,910	21,540	*21,150	14,080	*16,700	10,390	13,260	8,190	*11,610	7,620	9.53 m
-3.0 m	kg	*26,970	*26,970	*25,570	21,790	*19,830	14,160	*15,670	10,450			*12,530	8,590	8.77 m
-4.5 m	kg	*27,670	*27,670	*21,620	*21,620	*16,950	14,500	*12,710	10,790			*12,240	10,570	7.63 m

SK520LC		Boom: 7.00 m Arm: 4.04 m Bucket: without Counterweight: 9,800 kg Shoe: 600 mm (Heavy Lift)																		
B \ A			1.5 m		3.0 m		4.5 m		6.0 m		7.5 m		9.0 m		10.5 m		At max. reach		Radius	
9.0 m	kg																	*7,940	*7,940	8.35 m
7.5 m	kg												*10,040	9,450				*7,590	*7,590	9.38 m
6.0 m	kg												*10,940	9,300				*7,500	*7,500	10.07 m
4.5 m	kg										*12,810	11,960	*11,540	9,000	*7,700	6,970		*7,600	6,960	10.50 m
3.0 m	kg					*24,010	23,770	*17,440	15,650	*14,180	11,340	*12,300	8,650	*10,100	6,810		*7,900	6,580	10.71 m	
1.5 m	kg					*27,510	22,010	*19,540	14,680	*15,430	10,780	*13,010	8,320	10,680	6,640		*8,410	6,450	10.70 m	
G.L.	kg					*26,600	21,240	*20,770	14,060	*16,280	10,360	13,160	8,070				*9,240	6,550	10.47 m	
-1.5 m	kg	*13,140	*13,140	*17,590	*17,590	*28,240	21,050	*20,990	13,780	*16,500	10,140	13,020	7,940				*10,540	6,920	10.01 m	
-3.0 m	kg	*19,570	*19,570	*25,200	*25,200	*26,480	21,200	*20,150	13,770	*15,900	10,120	*12,650	7,990				*12,010	7,690	9.28 m	
-4.5 m	kg			*31,210	*31,210	*23,250	21,630	*17,990	14,020	*13,990	10,330						*12,080	9,210	8.22 m	
-6.0 m	kg					*17,690	*17,690	*13,480	*13,480								*11,520	*11,520	6.66 m	

SK520LC		Boom: 7.00 m Arm: 3.00 m Bucket: without Counterweight: 9,800 kg Shoe: 600 mm (Heavy Lift)														
B \ A			3.0 m		4.5 m		6.0 m		7.5 m		9.0 m		At max. reach		Radius	
9.0 m	kg													*11,450	*11,450	7.31 m
7.5 m	kg								*12,560	12,430				*10,620	10,050	8.46 m
6.0 m	kg								*13,140	12,130	*12,310	9,010		*10,300	8,600	9.23 m
4.5 m	kg			*22,930	*22,930	*17,030	16,220	*14,210	11,660	*12,660	8,820		*10,310	7,790	9.70 m	
3.0 m	kg					*19,300	15,240	*15,410	11,150	*13,220	8,560		*10,610	7,370	9.92 m	
1.5 m	kg					*20,880	14,530	*16,370	10,720	13,420	8,330		*11,210	7,260	9.91 m	
G.L.	kg			*19,500	*19,500	*21,400	14,170	*16,810	10,450	13,260	8,180		12,000	7,450	9.66 m	
-1.5 m	kg	*15,300	*15,300	*27,070	21,700	*20,860	14,090	*16,490	10,370	*13,120	8,180		*12,700	8,010	9.16 m	
-3.0 m	kg	*28,100	*28,100	*24,330	22,010	*19,140	14,240	*15,030	10,490				*12,590	9,170	8.36 m	
-4.5 m	kg			*19,810	*19,810	*15,580	14,670						*11,880	11,630	7.16 m	

SK520LC		Boom: 6.50 m ME Arm: 2.60 m ME Bucket: without Counterweight: 10,300 kg Shoe: 600 mm (Heavy Lift)														
B \ A			3.0 m		4.5 m		6.0 m		7.5 m		9.0 m		At max. reach		Radius	
9.0 m	kg													*13,040	*13,040	6.25 m
7.5 m	kg								*13,760	12,440				*11,310	*11,310	7.57 m
6.0 m	kg					*15,570	*15,570	*14,100	12,360					*10,500	10,140	8.42 m
4.5 m	kg					*17,460	16,600	*14,870	11,930					*10,170	9,060	8.93 m
3.0 m	kg					*19,540	15,630	*15,860	11,440	*13,850	8,800		*10,170	8,540	9.17 m	
1.5 m	kg					*21,010	14,920	*16,650	11,030	13,800	8,630		*10,490	8,420	9.16 m	
G.L.	kg					*21,390	14,560	*16,870	10,790				*11,190	8,710	8.89 m	
-1.5 m	kg			*26,690	22,280	*20,560	14,520	*16,110	10,780				*12,490	9,520	8.35 m	
-3.0 m	kg	*28,900	*28,900	*23,210	22,680	*18,100	14,790						*12,860	11,270	7.46 m	
-4.5 m	kg			*16,890	*16,890	*11,390	*11,390						*10,800	*10,800	6.07 m	

Notes:

- Do not attempt to lift or hold any load that is greater than these lift capacities at their specified lift point radius and heights. Weight of all accessories must be deducted from the above lift capacities.
- Lift capacities are based on machine standing on level, firm, and uniform ground. User must make allowance for job conditions such as soft or uneven ground, out of level conditions, side loads, sudden stopping of loads, hazardous conditions, experience of personnel, etc.
- Bucket pin attachment point defined as lift point.
- The above lift capacities are in compliance with ISO 10567. They do not exceed 87% of hydraulic lift capacity or 75% of tipping load. Lift capacities marked with an asterisk(*) are limited by hydraulic capacity rather than tipping load.
- Operator should be fully acquainted with the Operator's and Maintenance Instructions before operating this machine. Rules for safe operation of equipment should be adhered to at all times.
- Lift capacities apply to only machine as originally manufactured and normally equipped by KOBELCO CONSTRUCTION MACHINERY CO., LTD.

Standard and Optional Equipment

Category	Description	SK520LC-11E	
		Standard	Mass excavation
ENGINE	ISUZU 6WG1 engine (EU Stage V compliant)	●	●
	Exhaust DOC DPD SCR system	●	●
	Alternator 24 V /90 A	●	●
	Starter motor 24 V/7 kW	●	●
	Batteries 2x 12 V (205 Ah)	●	●
	Reversible hydraulic drive cooling fan	●	●
	Auto deceleration function	●	●
	Auto idle stop	●	●
HYDRAULIC SYSTEM	3 work modes H, S, Eco	●	●
	Power boost (37.8 MPa {385 kgf/cm ² })	●	●
	Heavy lift mode	●	●
	Pressure release function	●	●
	Independent travel function	●	●
	Auto warm up system	●	●
	Proportional Hand Control (for Rotation & N&B pipping)	●	—
	Proportional Hand Control (for N&B pipping)	—	○
	Hydraulic oil VG32	●	●
	Hydraulic oil VG46	○	○
	Hydraulic oil VG68	○	○
PIPING	Rotation & N&B pipping	●	—
	Standard pipping	—	●
	N&B pipping	—	○
	QH pipping	●	○
CABIN	Air suspension seat with heating	●	●
	10-inch colour monitor	●	●
	LED door light	●	●
	Air-conditioner	●	●
	DAB+ radio (FM/AM & AUX & USB & Bluetooth* & hands-free telephone)	●	●
	Parallel wiper	●	●
	12 V power outlet	●	●
	Rain visor	○	○
LIGHTS	Sun screen	○	○
	LED work lights ; 2 on boom, 1 on upper frame, 2 on rear counterweight	●	●
WORKING EQUIPMENT	LED work lights ; 2 on cab top front	○	○
	Standard boom (7.00 m)	●	—
	ME Boom (6.50 m)	—	●
	Standard arm (3.45 m)	●	—
	Short arm (3.00 m)	○	—
	Long arm (4.04 m)	○	—
	ME arm (2.60 m)	—	●
COUNTERWEIGHT	Standard C/W (9,800 kg)	●	—
	Heavier C/W (10,300 kg)	—	●
UNDERCARRIAGE	600 mm steel shoe	●	●
	600 mm HD steel shoe	○	○
	600 mm HD double grouser shoe	○	○
	800 mm steel shoe	○	○
	900 mm steel shoe	○	○
	Additional track guides (two additional per side)	○	○
	Lower frame guard	●	●
SAFETY	Engine emergency stop switch	●	●
	Pump emergency mode (KPSS release switch)	●	●
	Emergency accel dial	●	●
	Emergency manual valve for lowering attachment	●	●
	Safety valve for boom and arm cylinder	●	●
	ROPS compliant cab (ISO 12117-2:2008)	●	—
	OPG Level II top guard (ISO 10262:1998)	●	●
	OPG Level II front guard (ISO 10262:1998)	○	○
	Eagle-eye view camera (Rear, Right, Left)	●	●
	Seatbelt indicator on display	●	●
	Travel alarm	○	○
OTHERS	Refueling pump	●	●
	Harness for engine room light	●	●
	RAL color	○	○
	KOMEXS	●	●

*The air conditioning system on this machine contains fluorinated greenhouse gas HFC-134a (GWP 1430). Quantity of gas 1.0 kg (CO₂ equivalent 1.5 t)
 Note: Bluetooth* is a registered trademark of the Bluetooth SIG Inc.

Note: This catalogue may contain attachments and optional equipment that are not available in your area. And it may contain photographs of machines with specifications that differ from those of machines sold in your areas. Please consult your nearest KOBELCO distributor for those items you require.
 Specialist equipment is needed to use this machine in demolition work. Before using it please contact your KOBELCO dealer.
 Due to our policy of continuous product improvements all designs and specifications are subject to change without advance notice.
 Copyright by **KOBELCO CONSTRUCTION MACHINERY CO., LTD.** No part of this catalogue may be reproduced in any manner without notice.

KOBELCO CONSTRUCTION MACHINERY EUROPE B.V.

Veluwezooom 15
 1327 AE Almere
 The Netherlands
 www.kobelco-europe.com

Enquiries To: